

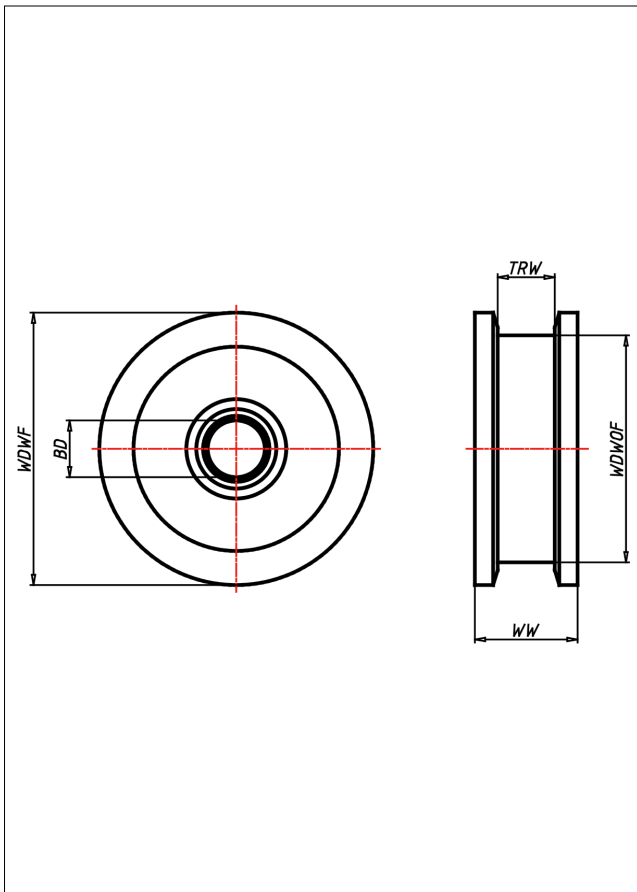

SDF

Doppel-Spurkranzrad

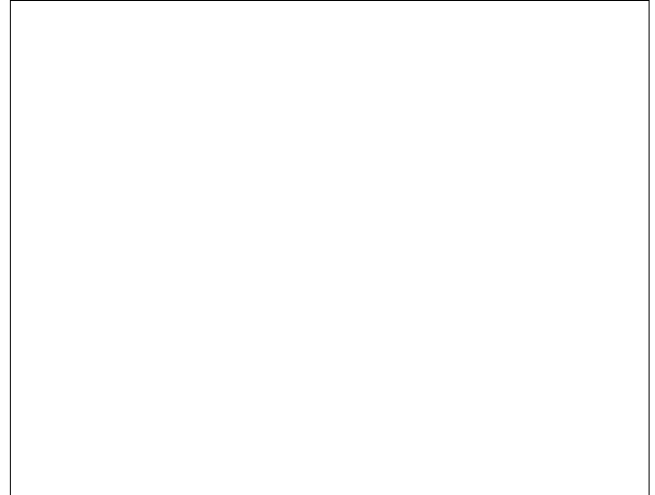

SDF Doppel-Spurkranzrad



Doppel-Spurkranzrad aus Stahl BS 970
Lauffläche sauber überdreht

- sehr hohe Tragkraft
- sehr abriebfest
- für hohe Temperaturen

Technische Details

ORDERNO (Artikel-nummer)	450 SDFTM 75
WDWOF (Rad-Ø o. Spurkranz / mm)	450
WDWF (Rad-Ø m. Spurkranz / mm)	495
TRW (Laufflächenbreite / mm)	80
WW (Radbreite / mm)	125
LC (Tragkraft / kg)	20100
HW (Nabellänge / mm)	125
WB (Radlager)	Schräggrollenlager
BD (Bohrungsdurchmesser / mm)	75